

**20A 45V Trench Schottky Diode**
**■ Applications**

Device optimized for low forward voltage drop to maximize efficiency in Power Supply applications

- AC-DC Adaptors
- DC-DC Converters

**■ Features**

- Schottky Barrier Chip
- Guard Ring Die Construction for Transient Protection
- Low Power Loss, High Efficiency
- High Surge Capability
- High Current Capability and Low Forward Voltage Drop
- Halogen Free and RoHS Compliant

**■ Product Summary**

$V_{RRM}$	45	V
$I_F@T_c=25^\circ\text{C}$	10x 2	A
$V_{F, TYP}@10A, T_c=25^\circ\text{C}$	0.48	V
$V_{F, TYP}@10A, T_c=125^\circ\text{C}$	0.45	V
$I_{R, MAX}@T_c=25^\circ\text{C}$	0.3	mA

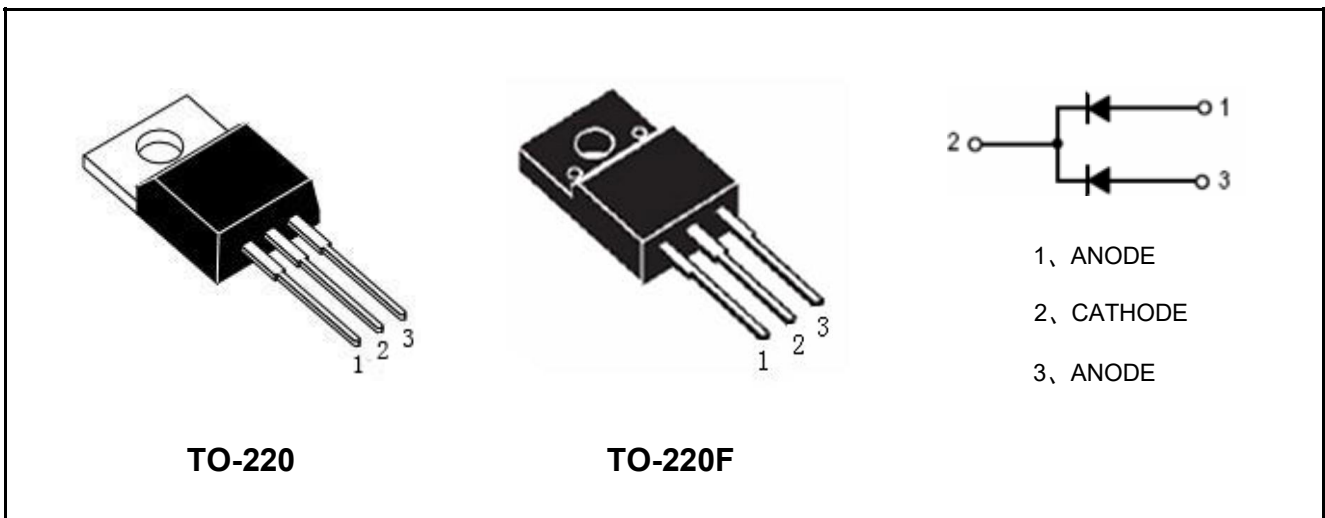

Marking	Package	Packaging	Min. package quantity
MC20T45CT	TO-220	Tube	1000
MF20T45CT	TO-220F	Tube	1000



**■ Absolute Maximum Ratings (Tc=25°C unless otherwise noted)**

Parameter	Symbol	Ratings	Unit
Peak Repetitive Reverse Voltage	$V_{RRM}$	45	V
Surge Peak Reverse Voltage	$V_{RSM}$		V
DC Peak Blocking Voltage	$V_R$		V
Continuous Forward Current	$I_{F(per\ leg)}$	10	A
	$I_{F(total)}$	20	A
Non-Repetitive Peak Surge Current((Surge applied at rated load conditions halfwave,single phase,60HZ)	$I_{FSM}$	275	A
Junction Temperature	$T_j$	150	°C
Storage Temperature	$T_{stg}$	-55-150	°C

**■ Thermal Characteristics**

Parameter	Symbol	Package	Max	Unit
Maximum Junction-to-Case	$R_{\theta JC}$	TO-220	2	°C/W
	$R_{\theta JC}$	TO-220F	4	°C/W
Maximum Junction-to-Ambient	$R_{\theta JA}$	TO-220	60	°C/W
	$R_{\theta JA}$	TO-220F	60	°C/W

**■ Electrical Characteristics (Per Leg) (Tc=25°C unless otherwise noted)**

Parameter	Symbol	Test Condition	Min	Typ	Max	Unit
Forward Voltage	$V_F$	$I_F=5A, T_J=25^\circ C$	-	0.4		V
		$I_F=5A, T_J=125^\circ C$	-	0.35		V
		$I_F=10A, T_J=25^\circ C$	-	0.48		V
		$I_F=10A, T_J=125^\circ C$	-	0.45		V
Reverse Current	$I_R$	$V_R=45V, T_J=25^\circ C$	-	0.06	0.3	mA
		$V_R=45V, T_J=125^\circ C$	-	-	100	mA

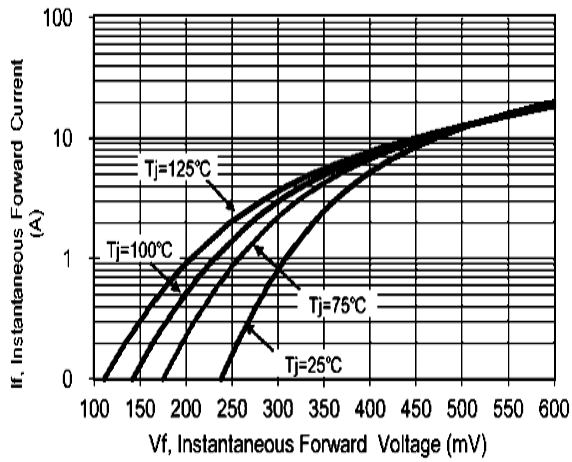
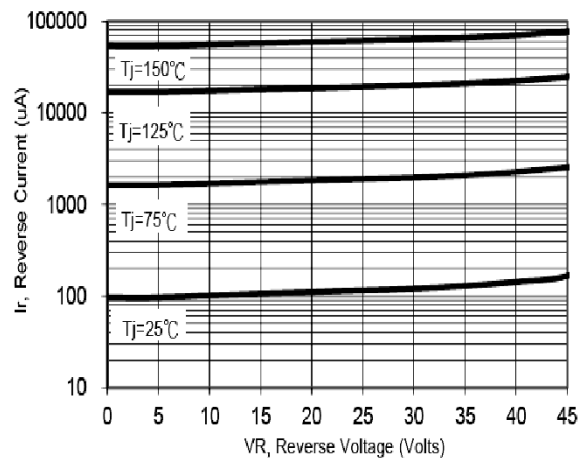
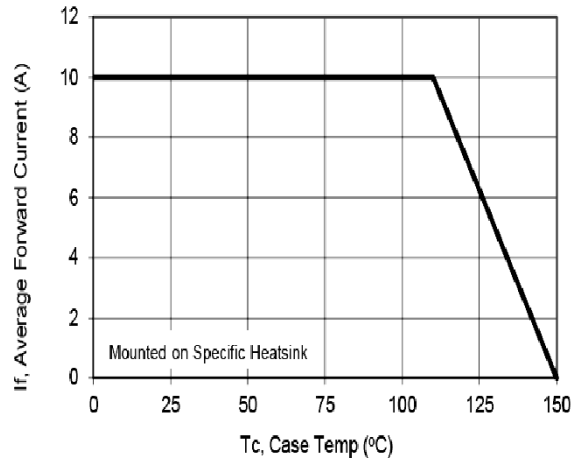

**■ Characteristics Curves**

**Forward Characteristics Per Diode**

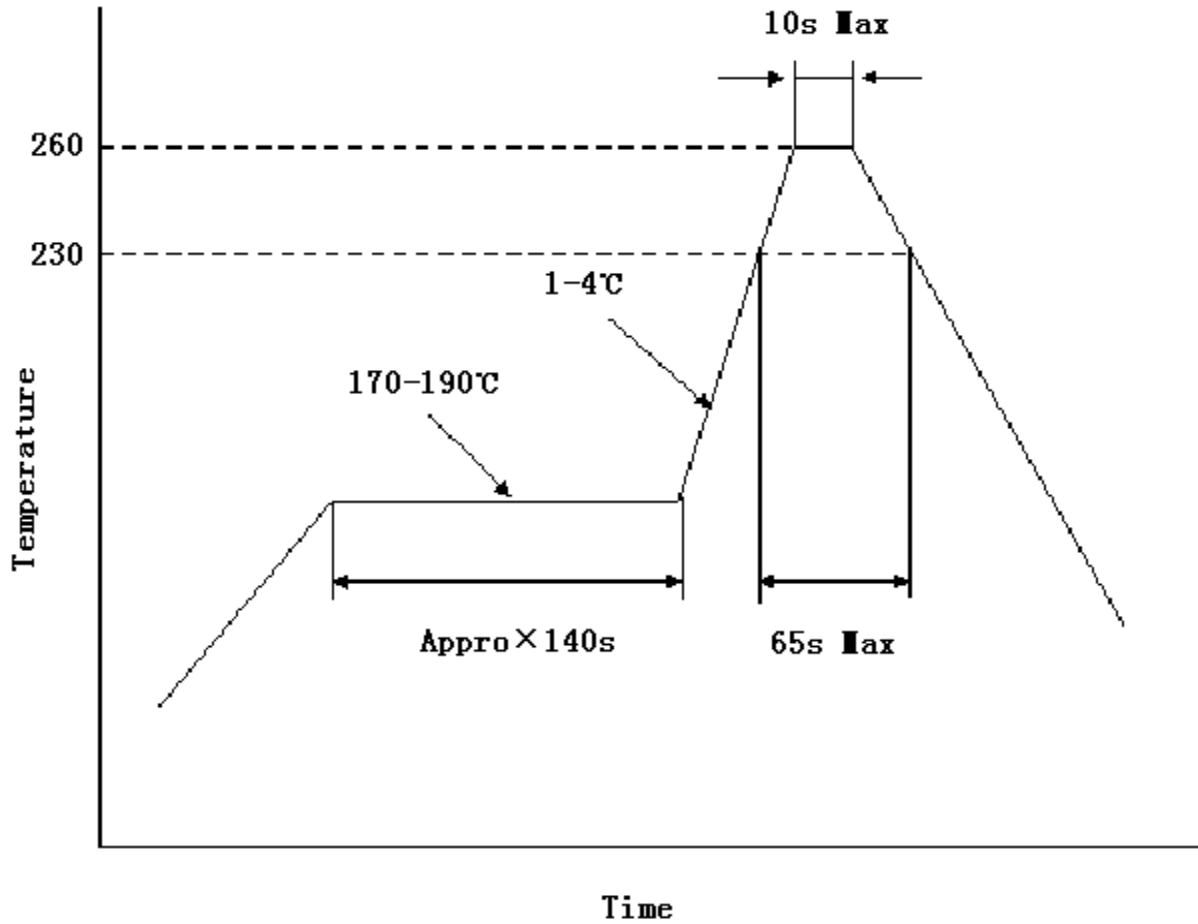
**Reverse Characteristics Per Diode**

**Current Derating Per Diode**



■ Reflow Soldering Temperature Profile



**TO-220 Package Dimensions**

Unit: mm

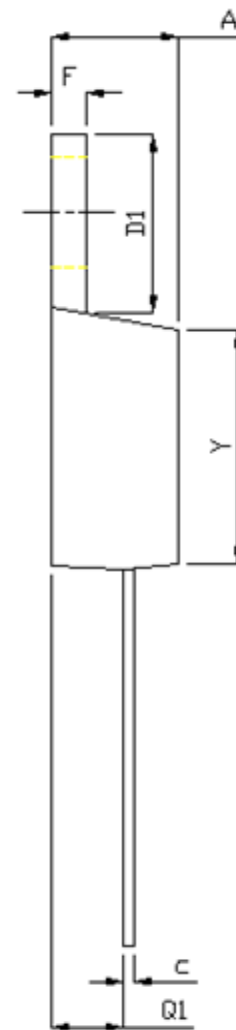
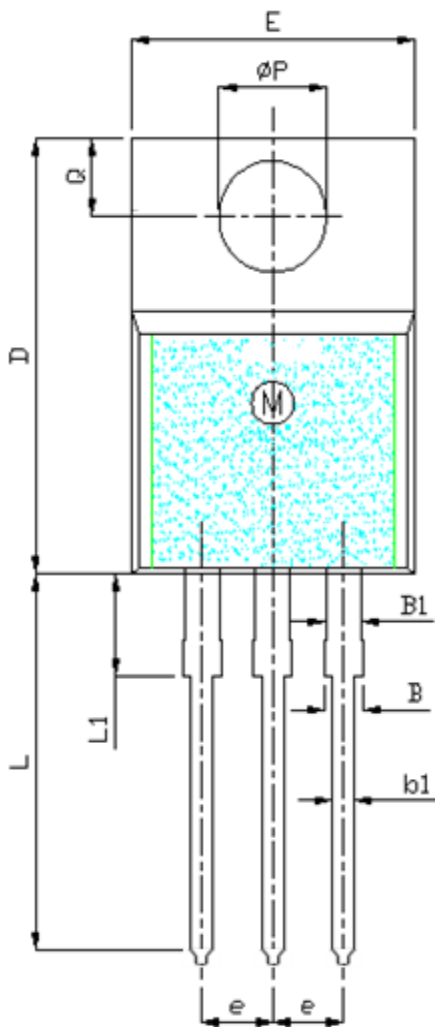
Symbol	Min	Nom	Max	Symbol	Min	Nom	Max
A	4.00		4.80	e	2.44	2.54	2.64
B	1.20		1.40	F	1.10		1.40
B1	1.00		1.40	L	12.50		14.50
b1	0.75		0.95	L1	3.00	3.50	4.00
c	0.40		0.55	ΦP	3.70	3.80	3.90
D	15.00		16.50	Q	2.50		3.00
D1	5.90		6.90	Q1	2.00		2.90
E	9.90		10.70	Y	8.02	8.12	8.22



**TO-220F Package Dimensions**

Unit: mm

Symbol	Min	Nom	Max	Symbol	Min	Nom	Max
A	4.5		4.9	E1	6.5	7	7.5
A1	2.3		2.9	e	2.44	2.54	2.64
b	0.65		0.9	L	12.5		14.3
b1	1.1		1.7	L1	9.45		10.05
b2	1.2		1.4	L2	15		16
c	0.35		0.65	L3	3.2		4.4
D	14.5		16.5	ΦP	3		3.3
D1	6.1		6.9	Q	2.5		2.9
E	9.6		10.3				

